PRECISE POSITIONING SHOCK ISOLATORS

by

Douglas P. Taylor

and

David A. Lee

Taylor Devices, Inc.

90 Taylor Drive

P.O. Box 748

North Tonawanda, NY 14120-0748

PRECISE POSITIONING SHOCK ISOLATORS

**Douglas P. Taylor and David A. Lee
Taylor Devices, Inc.
90 Taylor Drive
North Tonawanda, NY 14120**

Conventional approaches to the shock isolation of delicate systems often involve the use of low frequency shock mountings. This type of mounting is not usable on systems where precise alignment must be maintained over a long period of time. This paper describes a new type of isolator which combines excellent attenuation with the ability to precisely maintain system alignment in the pre and post shock environment. Computer simulation and test results are also provided.

INTRODUCTION

In the field of shock attenuation, there has been a necessary trade-off between the need for precise positioning of sensitive elements and the need for shock isolation. Conventional shock isolators, by their very nature, have soft springing. Their inherent low frequency effectively attenuates all high frequency shock. However, this same inherent low frequency also causes the system that is isolated to move around a great deal in normal operation. This is not acceptable for position sensitive equipment, such as navigators, sensors, and fire control directors. Indeed, it is objectionable for a great deal of deck mounted equipment.

A recently developed self-contained shock isolation system overcomes this difficulty by providing mechanically rigid mounting under normal operations. This isolator design strokes only when a shock transient occurs, and then restores itself to a rigid connection when the shock has passed.

This new shock isolator is called a Tension-Compression Isolator because it can stroke in either direction away from its rigidly held neutral position. Stroking occurs only when the load on the device exceeds a preset value. This type of operation can be thought of as a mechanical "fuse" with transmitted load or acceleration limited to a predetermined level.

Figures 1 through 3 show a cutaway of the Tension-Compression Isolator and depict its action. The device provides a built-in preload which is combined with a spring force plus a damping action. Spring forces are obtained by compressing a special silicone base fluid medium. Damping forces are obtained by orificing the medium at the same time it is compressed. The parameters of preload, spring force, and damping are sized and proportioned to minimize isolator deflection and transmitted acceleration forces.

Optimization of the shock isolator performance is done through extensive computer simulation. Models of the Tension-Compression Isolator's dynamic behavior are available in quickBASIC, non-linear NASTRAN, and a software package called TUTSIM®. All three programs have been used to predict dynamic behavior of both rigid and flexible structures. These predictions have been verified through shock testing at both the component and systems level. Results of shock testing showed close correlation with analytic predictions.

This paper describes the Tension-Compression Shock Isolator and its action. It also covers the three methods of computer simulation that have been successfully used. Test results are included.

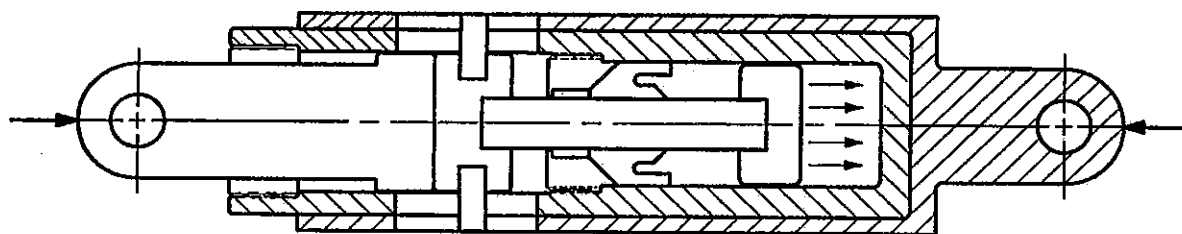

FIGURE 1
COMPRESSION OPERATION

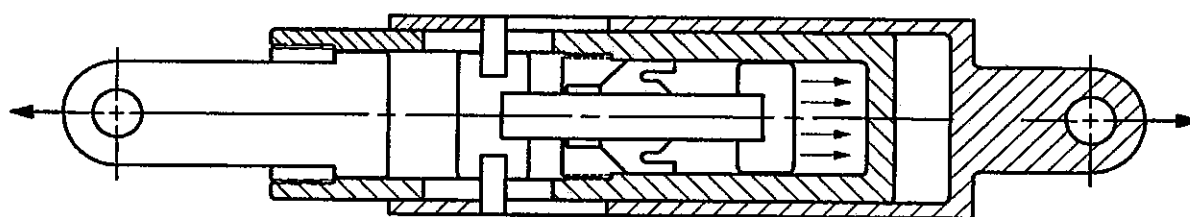
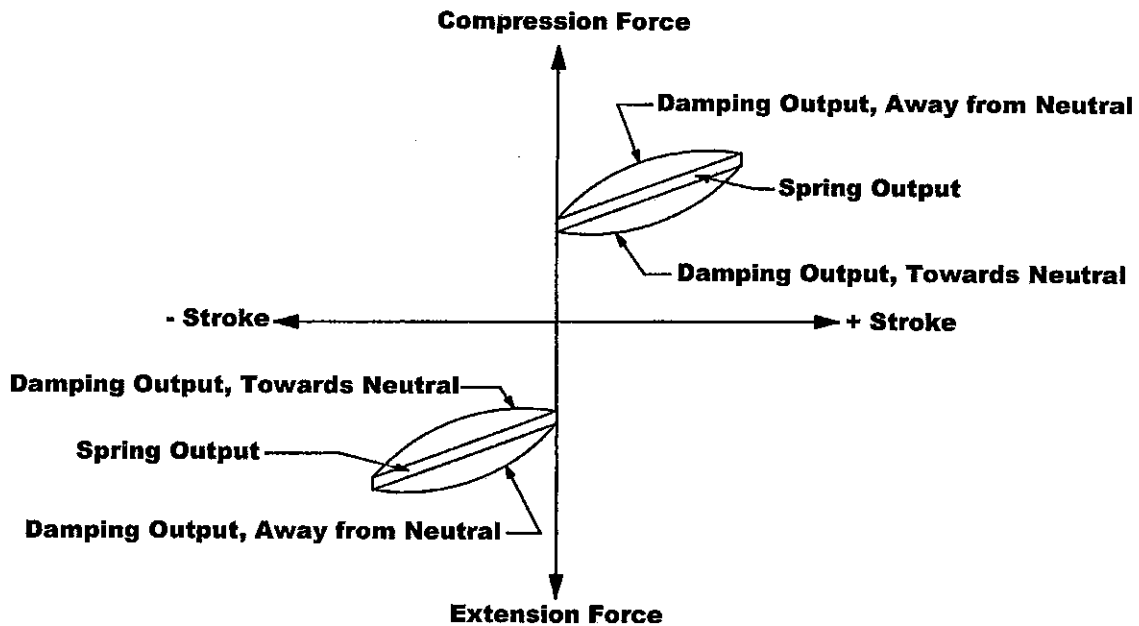

FIGURE 2
TENSION OPERATION



**FIGURE 3
OPERATIONAL OUTPUT**

EVOLUTION OF THE ISOLATOR DESIGN

The electronics revolution has greatly improved the performance of Defense products; yet the development of complementary shock isolation systems has not occurred. In general, the vast majority of isolation systems make use of a mounting with an inherently low natural frequency to attenuate shock pulses. This approach is not acceptable if the system to be isolated is alignment sensitive.

Critical alignment requirements can be found in many electronic systems, such as Navigators, Fire Control Directors, target detection and acquisition devices, and missile launchers utilizing remote radar or sensors for inertial guidance. The conventional soft mount style of shock isolation is totally inadequate for this type of system. For example, an inertial navigation system must be closely aligned to the centerline of the vehicle it is mounted in. Typically, mechanical alignment should be held to .005 degrees or less to allow accurate navigation. The venerable helical steel cable mounting typically has 2-4 inches of travel available for attenuation. Comparison of pre and post shock lengths of this isolator type shows as much as plus or minus .25 inch length change. In addition, the imposition of wind, wave, or minor seismic loadings can also cause a significant change in system alignment. This type of parameter drift is not acceptable for an inertial navigator.

Over the past decade, various solutions to the problem of shock isolation combined with alignment have been utilized. Some of these are:

1. Reversion to Hard Mounting

This solution bolts the system rigidly to ground with no isolation utilized. Electronics must be procured in shock resistant form, and mechanical platforms and supports must be made with greatly increased strength (and weight).

2. Addition of a System Alignment Mechanism

This solution retains the soft isolation mounting, but adds a mechanism of anti-sway bars, links, or mechanical slides. The mechanism serves to allow a minimum of rotational system motion. In some cases, isolation system travel is limited to a single axis. These complex mechanisms have proven to be heavy and costly. In addition, system reliability and maintainability suffer due to the large number of parts.

3. Addition of a Discrete Isolator Alignment Mechanism

This method adds additional support springs and mechanisms to each isolator in an attempt to accurately position the isolator and reposition it in the post shock mode. While generally more accurate than a system alignment mechanism, this mechanism also has poor reliability and maintainability.

The above attempts to solve the isolator alignment problem have met with only limited success. Costs are high; performance has not been as expected. What is needed is a simple soft-mount type isolator with the ability to accurately reposition a system in the post-shock environment. The solution must involve a minimum of parts; high reliability must be maintained.

In the 1980's, Taylor Devices set out to find a solution to the problem of precise positioning isolators. The design concept which evolved was to incorporate the most compact spring and damper combination with the simplest possible connection mechanism.

SPRING-DAMPER DESIGN

After reviewing the various combinations of elements which produce a spring-damper output, a component known as a liquid spring-damper was selected as being both simple and compact. This device consists of a cylinder full of pressurized fluid. The fluid is compressed by intrusion of a piston rod into the fluid volume with the addition of a damping system which orifices the same volume of oil that is being compressed. Both spring and damping forces can thus be obtained from the same fluid medium. In addition, since the maximum velocity of a shock isolator usually occurs during the first portion of the event, the maximum hydraulic damping force will occur towards the beginning of stroke when spring pressure from the compressed fluid is minimum. At the limit of isolator travel, it is assumed that the portion of the shock causing the isolator to displace has been attenuated, the relative isolator velocity should be zero. At this point in displacement, damping force should be small; yet spring forces from the compressed fluid are now at maximum values. This indicates that proper selection of relative piston rod and damping head areas should provide a

hydraulic device with a relatively constant internal pressure throughout a shock transient. The pressure vessel to contain this pressure will therefore be optimized in design throughout a shock. Liquid springs are extremely compact. For example, a two inch diameter liquid spring of 12 inch overall length can have a stroke of 3 inches with a maximum spring force of 13,000 lb. available. As much as 20,000 lb. of damping force can be added to the 13,000 lb. of spring force.

The advantages of a liquid spring-damper include a compact and simple design, the use of a single oil column for both spring and damping forces, and the ability to minimize pressure vessel size by maintaining a near constant operating pressure during a shock transient.

Figure 4 depicts the liquid spring-damper and its major parts.

Special fluids having inherent high compressibility are absolutely necessary for a properly functioning and optimized liquid spring. Typically, fluids from the silicone family are used due to their high inherent compressibility and benign nature. Silicones exhibit operating volumetric compressibility of 15% at peak operating pressures in the 30,000 pounds per square inch region.

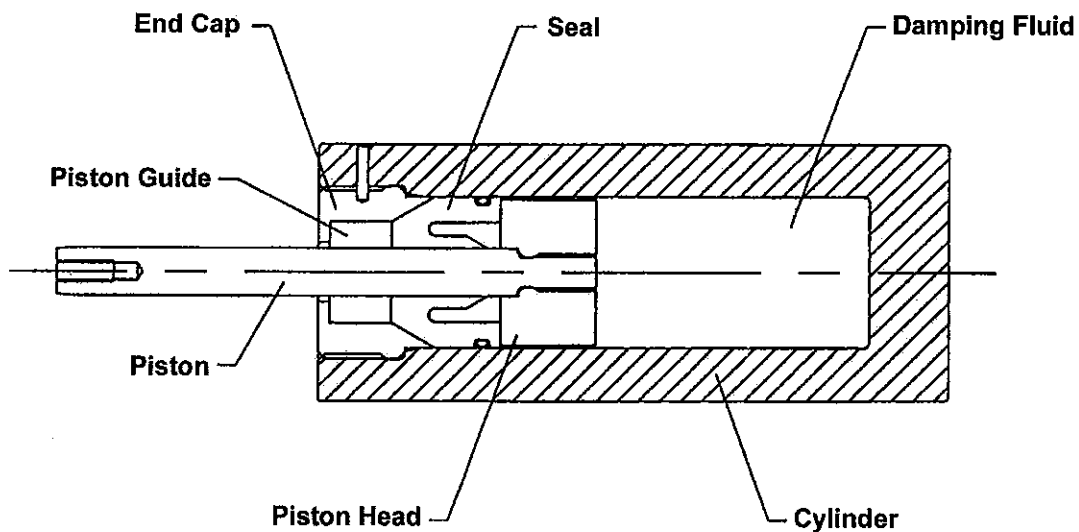

FIGURE 4
LIQUID SPRING - DAMPER

Unlike conventional hydraulic components, liquid springs thrive on high pressure. Special seal designs and finishing techniques are used to insure that no static leakage will occur in the long term. The basic sealing concept is to use extremely soft seals that will cold flow under pressure to seal even microscopic surface finish patterns. This type of seal must be well supported to prevent extrusion.

To use this type of device in an alignment sensitive application, the fluid must be pressurized such that the piston rod is loaded against a mechanical hard stop. Typically, precharge pressures of 10,000 pounds per square inch are utilized with a maximum pressure at full stroke of 30,000 pounds per square inch. The resulting spring output curve is not linear. Using a 10,000 to 30,000 pounds per square inch range, the spring rate at 30,000 pounds per square inch will be roughly 2.2 times the spring rate at 10,000 pounds per square inch. As in most compressible material devices, the largest change in spring rate occurs towards the end of travel at maximum load.

The damping system within the liquid spring must be carefully selected and designed when transient shock attenuation is required. First, since we are using a high pressure spring, it is necessary to use a high pressure damping system if the design is to be optimized for size and weight. Conventional hydraulic damping will be essentially in accordance with Bernoulli's equation, because fluid velocity will be high. This means that the damping system will vary its output force with respect to the square of the fluid speed within the damper. Unfortunately, this type of damping is usually unacceptable for a shock isolator since the exact wave form of the transient is highly variable. Small wave shape and magnitude variation will cause large damping force changes due to the speed squared output from the damping system. Various approaches have been tried which attempt to vary the area of the Bernoullian orifice along the stroke of the liquid spring. These include tapered pins inserted into an orifice hole, annular flow orifices running inside a tapered cylinder bore, or a metering tube with "piccolo holes" inserted inside the liquid spring cylinder. The orifice that results is essentially a series of squares law orifices that change area with respect to piston rod position. Unless the shock pulse wave form is exactly known, analysis reveals that any combination of Bernoullian orifices presents a high risk to the design. For example, if the initial portion of the transient were to stroke the isolator at a speed 20% higher than predicted, damping forces would raise 44%. The accompanying large change in system g-loads, with only a small velocity shift, presents an unacceptable risk to most isolation system projects. Various types of Bernoullian damping orifices are shown schematically in Figure 5.

Two types of high pressure orifice designs are available which do not exhibit squares law behavior. One type is the so-called Pressure Responsive Valve (PRV). The PRV consists of an orifice hole that is blocked by a spring loaded valve. Flow through the hole is metered by the valve and its loading spring. Typically, PRV's produce damping functions varying force with respect to the fluid speed raised between the powers of 0.5 to 1.2 ($F = CV \text{ EXP } .5$ to $F = CV \text{ EXP } 1.2$). A schematic of a PRV is shown in Figure 6.

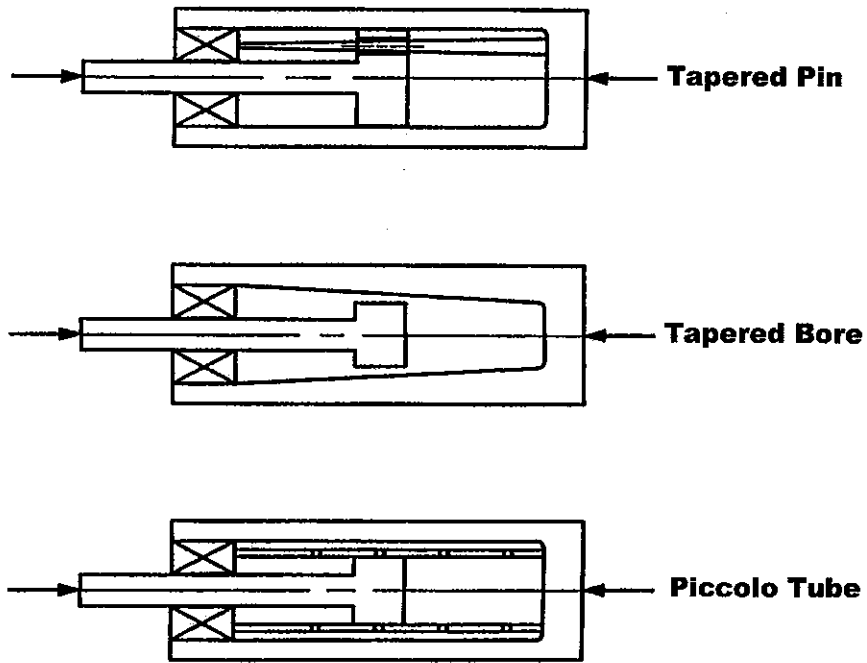

**FIGURE 5
BERNOULLIAN DAMPING ORIFICES**

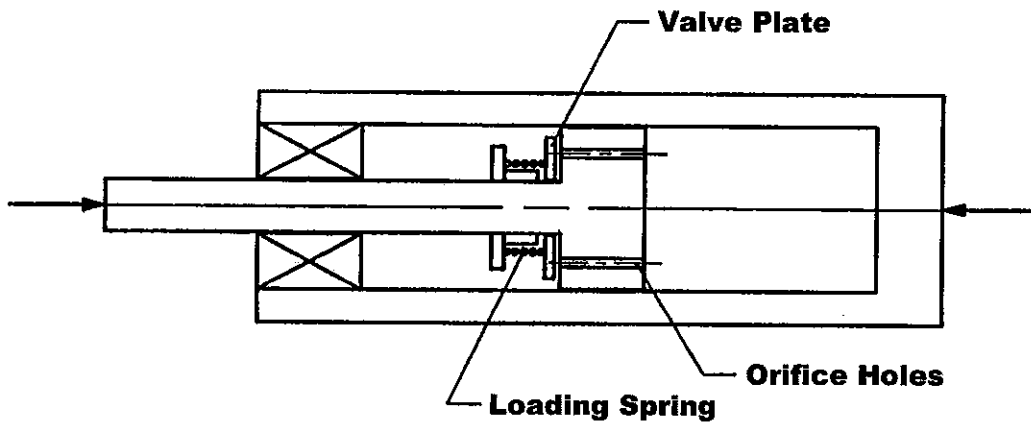

**FIGURE 6
PRESSURE RESPONSIVE VALVE ORIFICE**

The second type of non-Bernoullian orifice uses fluidic control to provide essentially the same type of controlled flow as a PRV. The Fluidic Control Orifice has no moving parts, but uses a series of specially shaped passages to alter flow characteristics with fluid speed. Fluidic Control Orifices, like the PRV, provide forces which can be set to vary with respect to the fluid speed raised between the power of 0.5 to 1.2. A schematic of a typical Fluidic Control Orifice is shown in Figure 7.

The exact damping function desired for the PRV or Fluidic Control Orifice is normally determined by repeated analytical runs. These determine optimum system g-loads and isolator size.

THE POSITIONING MECHANISM

A liquid spring-damper design is executed most simply as a compression acting device. In other words, compressing the device overcomes the spring prepressurization loading, and an additional increase in applied force will stroke the liquid spring. If the piston rod is forced in at high speed, damping forces will be generated which are additive to the spring force. If the piston rod is released, the spring force will extend the rod. At the same time, damping forces will now oppose this rod motion.

To package this device as a shock isolator with alignment capabilities, a mechanism must be added to the liquid spring. Since shock inputs can either compress or extend the isolator, this mechanism must compress the liquid spring whenever the isolator is compressing *or* extending from its neutral position. In addition, the neutral position must be mechanically rigid in the pre or post shock environment. The isolator must hold this neutral position irrespective of temperature, intensity of prior shock transients, and prior number of shock cycles.

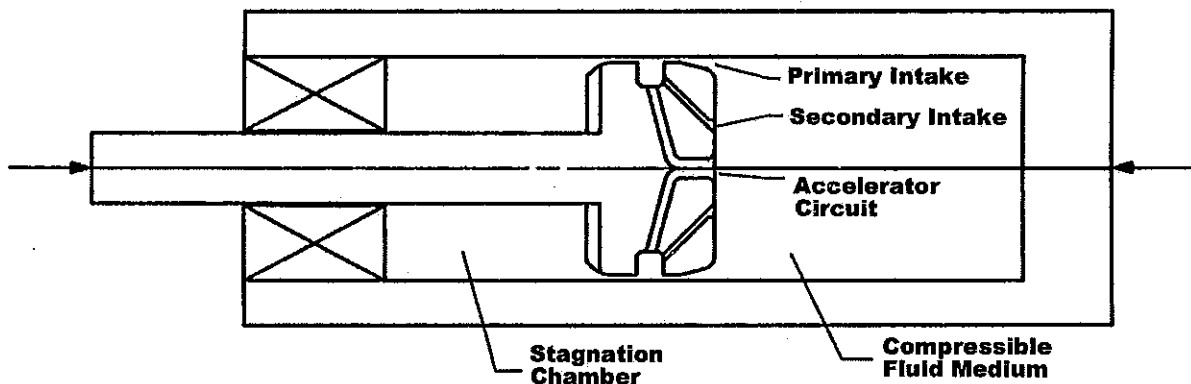

FIGURE 7
A FLUIDIC CONTROL ORIFICE

At first glance, these tasks seem to require an elaborate and complex mechanism. However, after extensive research, Taylor Devices adapted a concept that has been used on railroad car draft gears for decades. A draft gear uses sliding plates and pins to convert motion of a compression spring to motion in both the extension and compression directions. In a railroad car, the addition of this mechanism to a spring enables the car to attenuate both the compression shock (as occurs when cars crash together) and draw bar tension shock (as occurs when a car in a train encounters an obstruction to motion not encountered simultaneously by the locomotive).

Adaptation of this mechanism to the liquid spring damper involves the addition of a slotted external tube and linkage. These connect to the basic liquid spring-damper of Figure 4, which is modified by an extension of its main cylinder forming a second slotted tube. Figures 8-10 depict the steps required. Figures 1-3 at the beginning of this paper depict operation of the complete device. When complete, the liquid spring damper is slightly precompressed by the linkage. This assures that the hard centering of the mechanism is independent of the internal parts of the liquid spring. Note that since the linkage sets the centered position, any variation in liquid spring force (due to temperature, service life limit, etc.) will have an effect on the precise positioning of the device. In addition, since the linkage either compresses or extends a single liquid spring-damper, performance is identical in either direction from center.

For use as a vertical shock isolator, the device's preload or centering force is usually set at the range of 5 g. This level is suitably high so as to insure system position under all normal operating conditions.

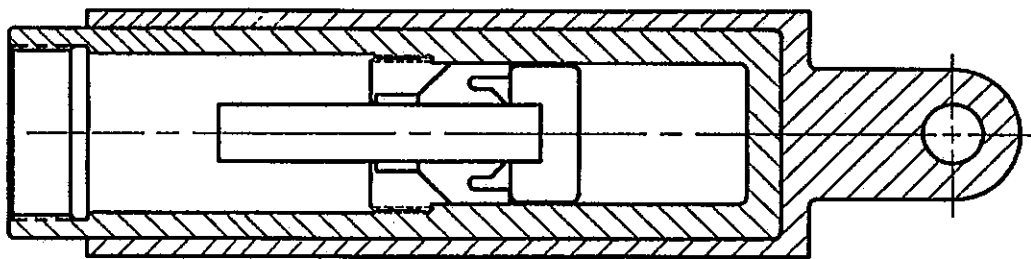

FIGURE 8
EXTEND CYLINDER AND ADD AN EXTERNAL SLEEVE

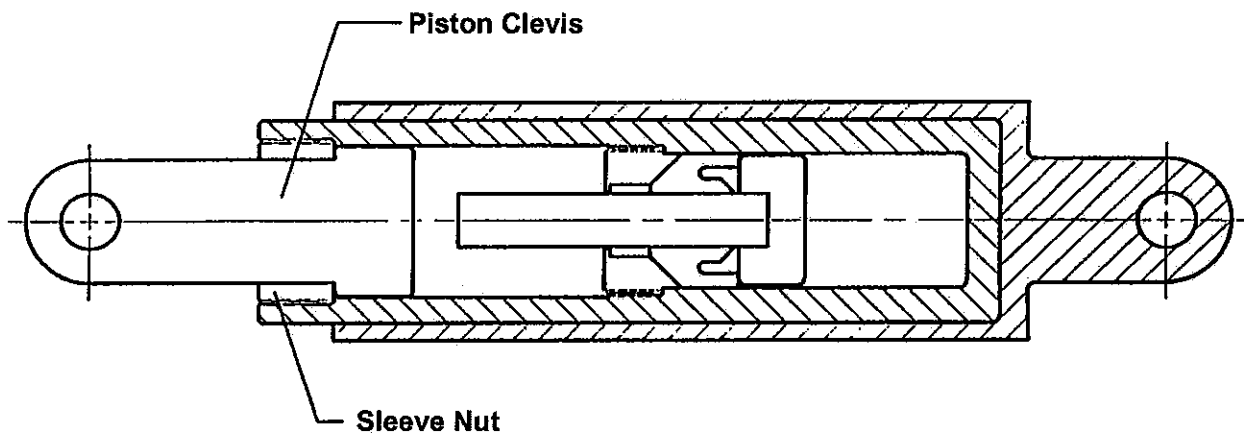

FIGURE 9
ADD PISTON CLEVIS AND SLEEVE NUT

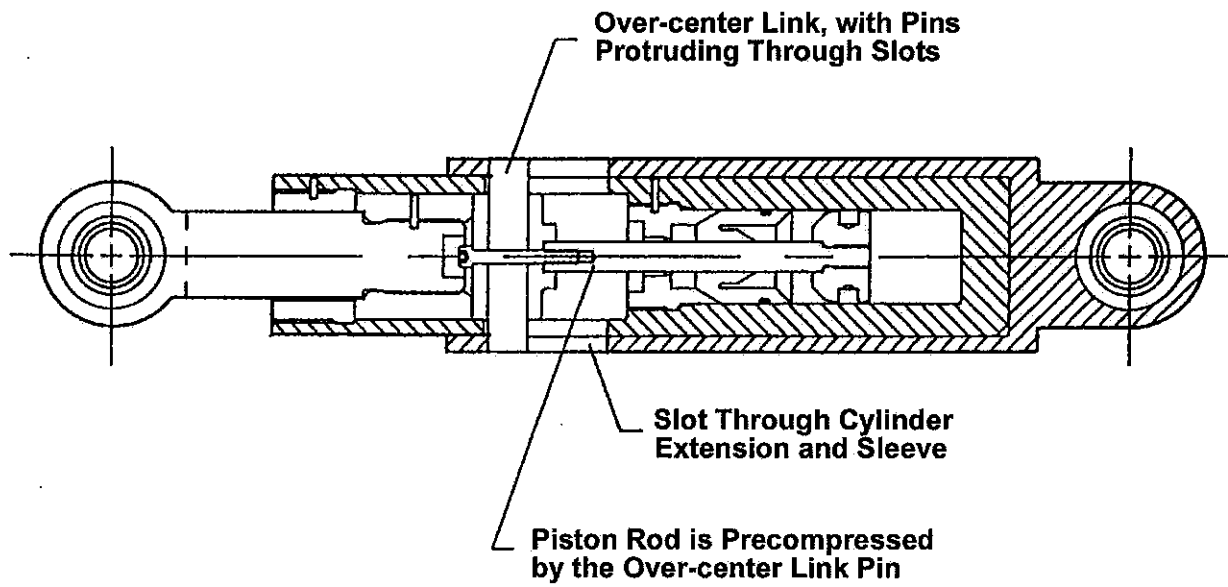

FIGURE 10
ADD OVER-CENTER LINK AND SLOTS, PRECOMPRESSING UNIT

MATHEMATICAL MODELING

An adequate mathematical model of the Precise Positioning Isolator must encompass the following performance parameters:

Preload: The amount of static spring force available from the liquid spring. The preload holds the isolator in a centered position.

Endload: The amount of static spring force available from the liquid spring at maximum compression or extension.

Stroke: The amount of deflection available from the liquid spring after the linkage is installed. The stroke available in the isolator is plus or minus the liquid spring-damper stroke. Thus, one inch stroke available in the liquid spring-damper provides plus or minus one inch isolator deflection from the centered position.

Spring Rate: For the precompressed liquid spring-damper, spring rate is equal to (endload minus preload) divided by stroke.

Damping, Away from Neutral: When the isolator is extending or compressing *away from* neutral, the liquid spring-damper is extending and a second damping function can be defined.

Damping, Towards Neutral: When the isolator is extending or compressing *towards* neutral, the liquid spring-damper is extending and a second damping function can be defined.

Gapping Phenomena: When the isolator is extending or compressing *towards* neutral, it is possible for the damping force to become equal to the liquid spring force. When this happens, the liquid spring can become uncoupled from the linkage for a brief period. In many cases, this uncoupling phenomena is used to reduce system g-loads by preventing high speed transients from being transmitted to the isolated system.

Each phase of operation of the Tension-Compression Isolator is illustrated in Figure 11. This figure shows the distinct operational motions, each having a unique isolation action. The spring and damping forces complement each other (i.e, are additive) for cases having a stroke direction away from neutral. The spring and damping forces oppose each other for cases with stroke directions toward neutral.

The operating parameters of the Tension-Compression Isolator make modeling challenging because the stroke and velocity dependencies are not as simple as for an isolator comprised of a conventional parallel spring-damper combination. In the Tension-Compression Isolator, the spring output is a function of stroke. The damping function depends on two variables: stroke direction and velocity. One velocity magnitude can produce four separate output forces depending on where in the stroke the action occurs.

Figure 12 illustrates the four unique isolation actions performed by the single Tension-Compression Isolator. The balanced relationship between spring and damping forces allows total output force to remain relatively constant for optimum performance.

Each distinct operational detail of the Tension-Compression Isolator can be represented in analog fashion for translation into computer code using conventional methods.

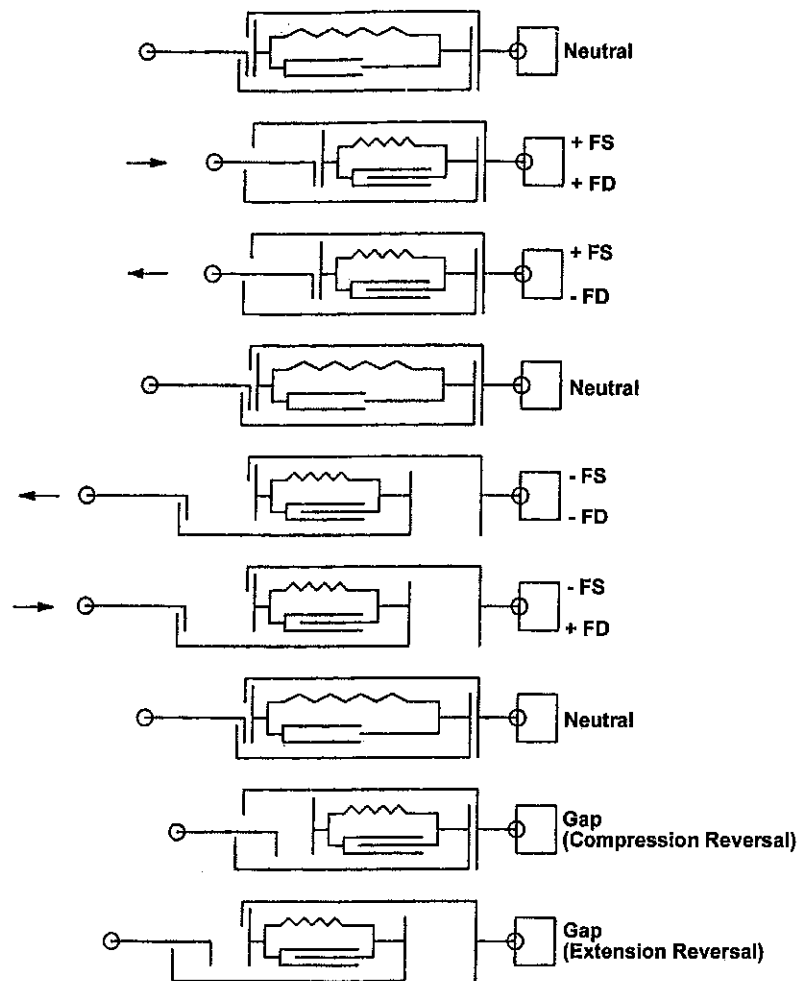

KEY:

- FS = Spring Force
- FD = Damping Force
- = Relative Velocity

FIGURE 11
TENSION-COMPRESSION ISOLATOR OPERATION

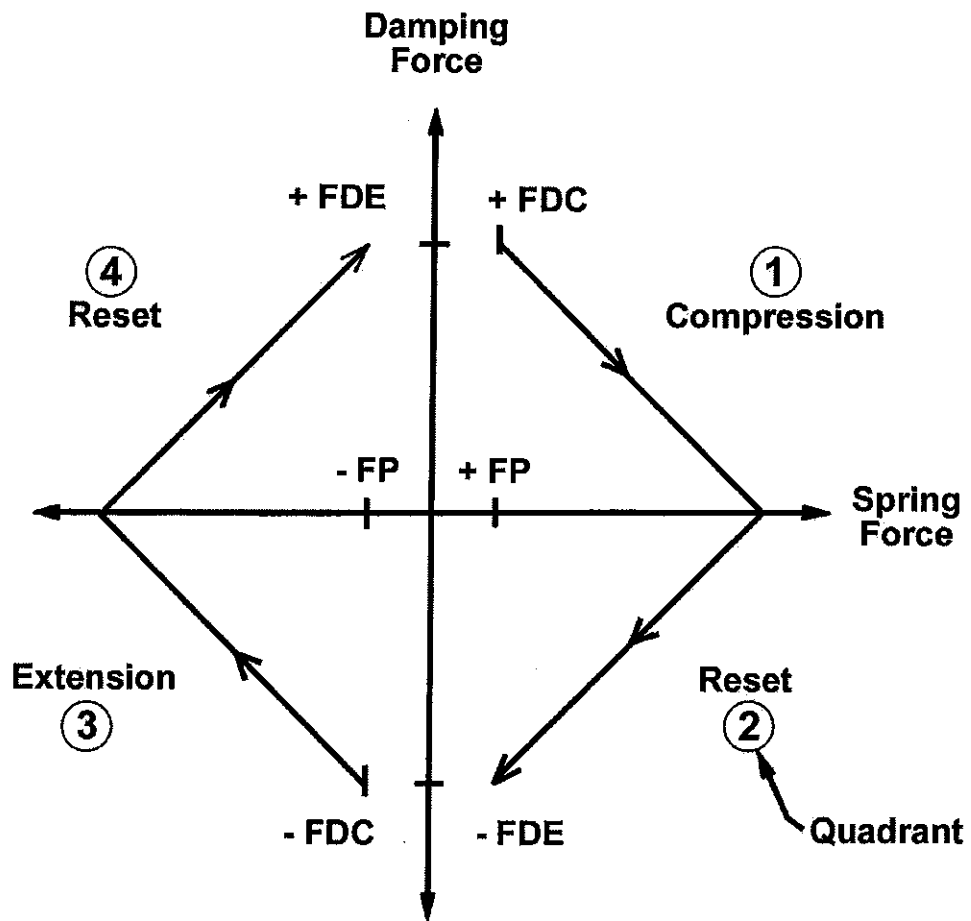

KEY:

- FP = Spring Preload
- FDC = Damping (away from neutral)
- FDE = Damping (towards neutral)

NOTE: Spring and damping forces complement each other to keep the total output force nearly constant.

FIGURE 12
FOUR QUADRANT ISOLATION EFFECTS

COMPUTER SIMULATION

The discrete logic describing the tension-compression unit performance can be converted into computer code. It is then possible to perform simulation analyses and verification comparisons.

Microsoft QuickBASIC version 4.0 was used for initial model formulation and to update critical gap condition logic paths. After evaluating alternate software packages with more extensive capability, the TUTSIM® Computer Language was chosen as best suited for PC based modeling of the Tension-Compression Shock Isolator. This software proved to be effective in representing the nonlinear spring, damping, and gap elements. In order to verify the TUTSIM® software and model, comparisons were made with already established benchmarks. TUTSIM® models were generated to allow response comparisons with NASTRAN and actual test data.

Figure 13 schematically shows a typical system mode. A 550 pound weight in a gravity field is suspended from ground by a Tension-Compression Isolator of known parameters.

A generic shock pulse is applied to the base, which would exercise the isolator in both tension and compression. The NASTRAN results for isolator deflection vs. time are provided in Figure 14.

TUTSIM® results for deflection vs. time compare quite well to NASTRAN. This is shown in Figure 15. Predicted maximum decelerations for the NASTRAN and TUTSIM® runs agree with plus or minus 10%.

Figure 16 depicts an actual test in which the Tension-Compression Isolator is attached in series to a relatively rigid mass supported by a low friction surface. The input for the test is a displacement command signal representative of a weapons grade shock pulse. A rigid body TUTSIM® simulation proves to be conservative in predicting isolation system responses. Figures 17 and 18 show measured test results and TUTSIM® results respectively for isolator stroke. Figures 19 and 20 show isolator output force for the same input conditions.

Computer simulation techniques have proven to be useful in performing shock simulation even with the relatively nonlinear shock isolation parameters of the tension-compression isolator. Spring and damping parameters can quickly be altered to meet user defined constraints. The overall driver may be displacement, reset time, g levels, or envelope. The shock isolator parameters can be easily adjusted for multiple simulation runs using user defined models, inputs, and constraints.

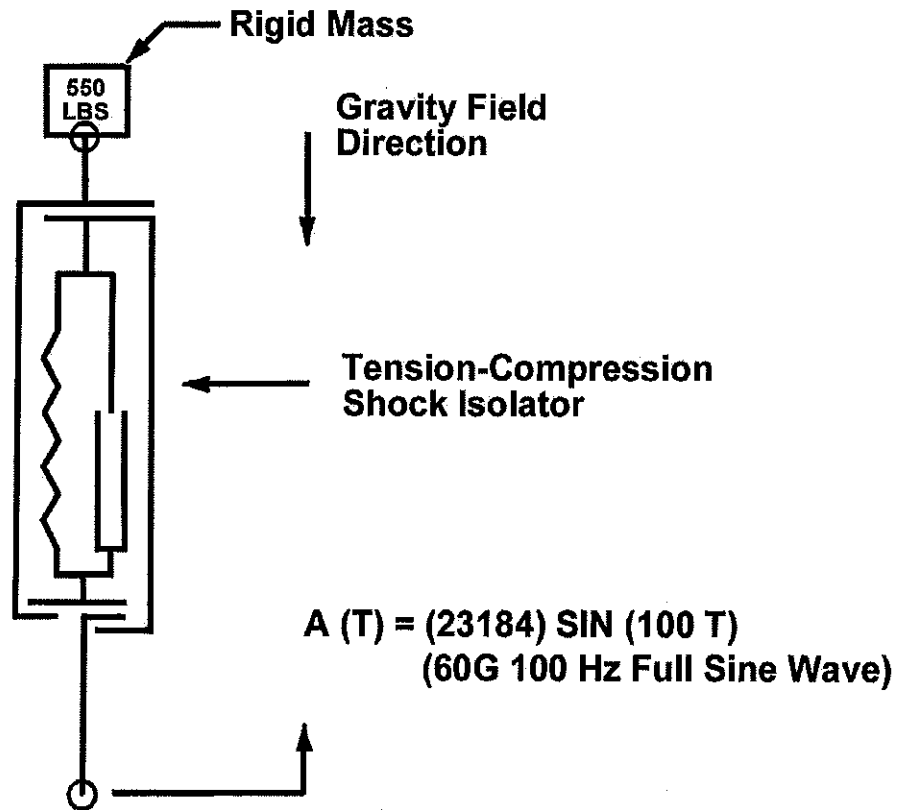

ISOLATOR PARAMETERS:

- FS = 1704 + 2107 (X) (Spring Force)
- FDC = 610 (V)⁶ (Damping Force - away from neutral)
- FDE = 221 (V)⁷ (Damping Force - toward neutral)

**FIGURE 13
NASTRAN MODEL (VERTICAL APPLICATION)**

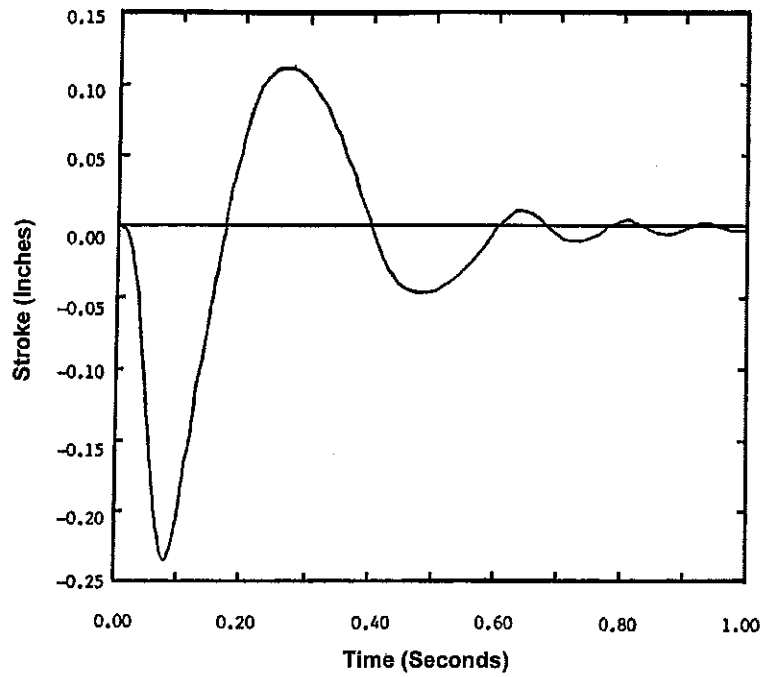

FIGURE 14
NASTRAN OUTPUT (STROKE)

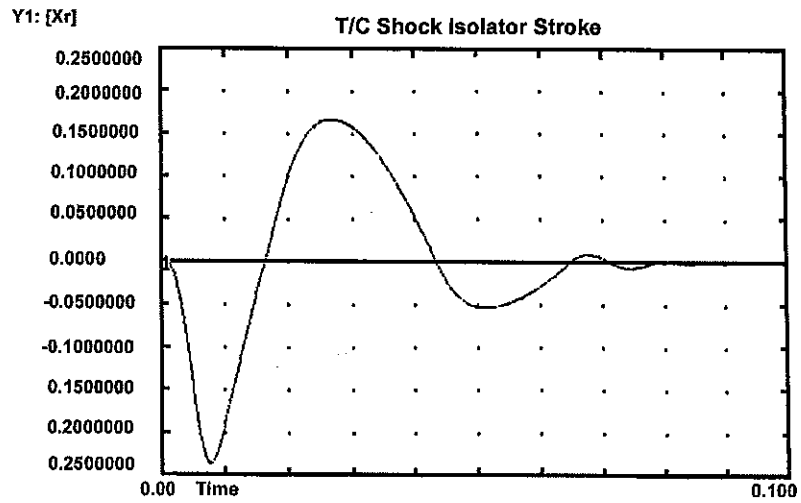
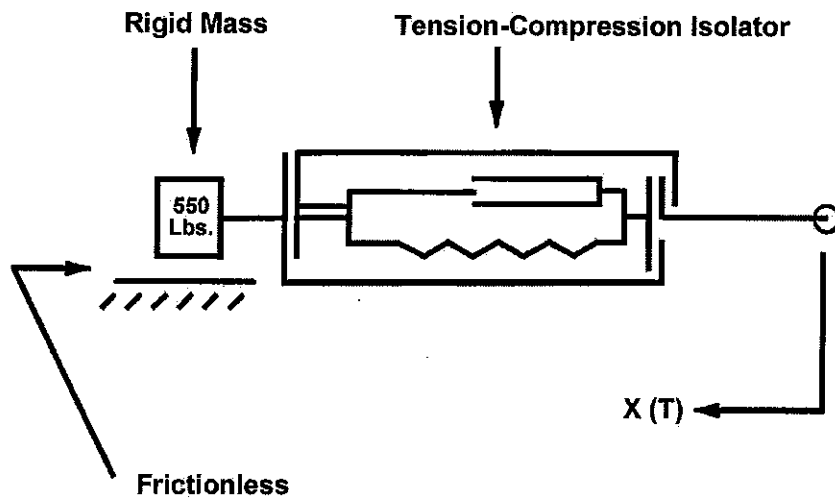

FIGURE 15
TUTSIM® OUTPUT (STROKE) – VERTICAL APPLICATION



X (T) = Displacement Command Signal for Generic Weapons Grade Shock Pulse

ISOLATOR PARAMETERS:

FS	=	1704 + 2107 (X)	(Spring Force)
FDC	=	610 (V) ⁶	(Damping Force - away from neutral)
FDE	=	221 (V) ⁷	(Damping Force - toward neutral)

FIGURE 16
ACTUAL TEST CASE (HORIZONTAL APPLICATION)

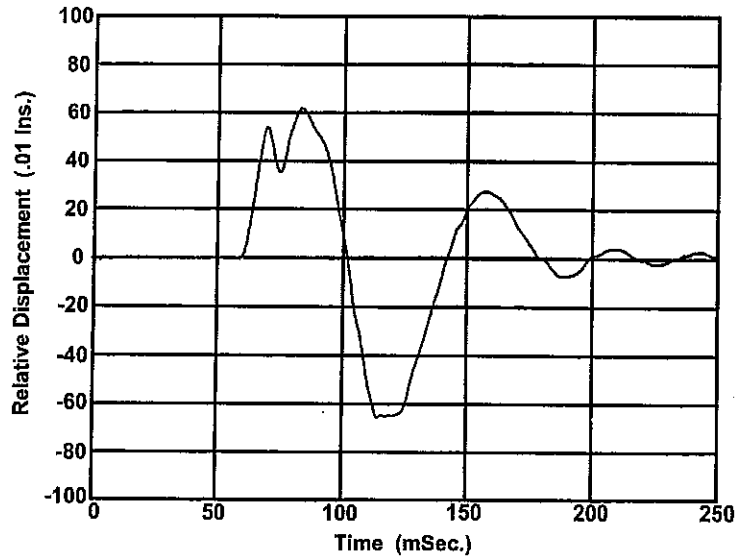

FIGURE 17
TEST OUTPUT (STROKE)

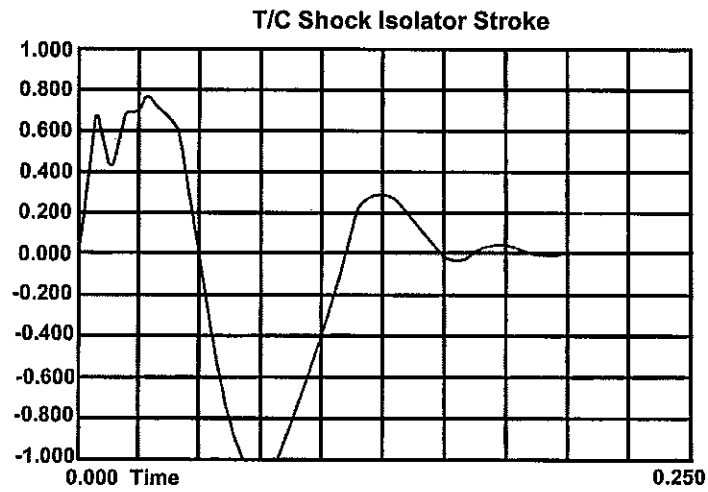

FIGURE 18
TUTSIM® OUTPUT (STROKE), HORIZONTAL APPLICATION

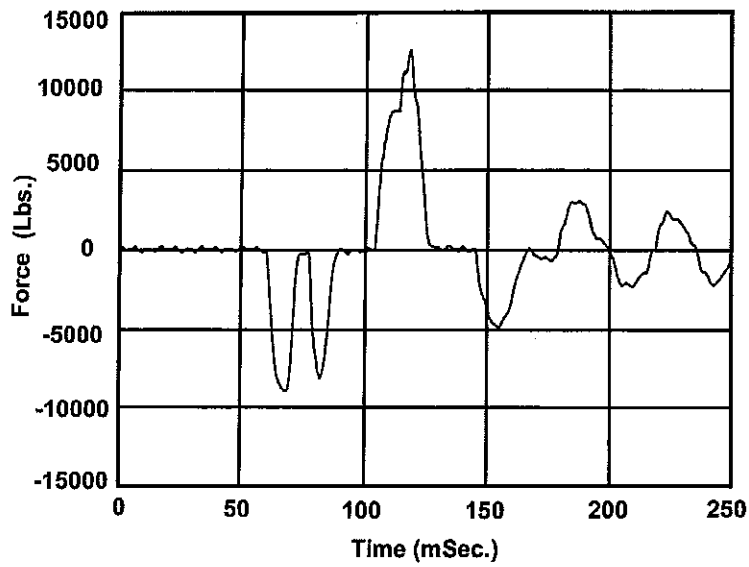

FIGURE 19
TEST OUTPUT (FORCE)

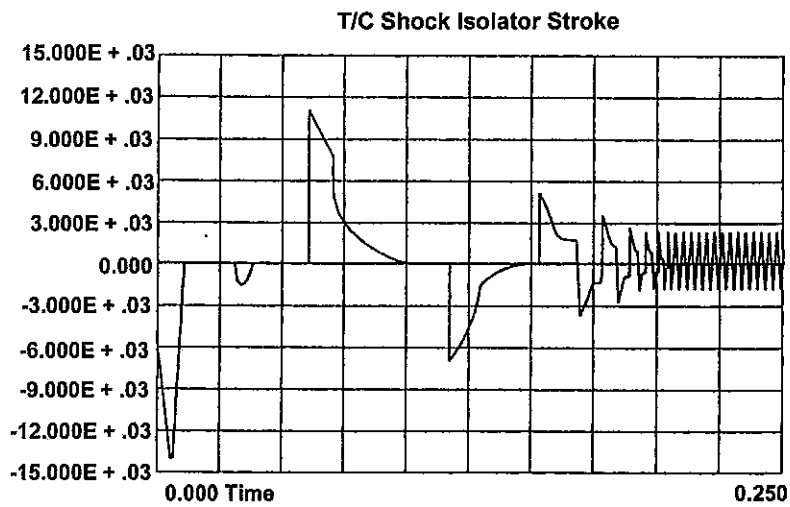

FIGURE 20
TUTSIM® OUTPUT (FORCE), HORIZONTAL APPLICATION

CONCLUSION

The Precise Positioning Shock Isolator is a cost effective way to attenuate weapons grade shock on alignment sensitive systems. The combination of parallel liquid spring and damping elements, along with an integral tension-compression mechanism, results in an extremely compact isolator package, offering great ease in installation. High reliability is inherent in the design due to the minimal number of parts involved. The device is entirely passive and requires no external power input. When incorporated into a system, the Precise Positioning Isolator will attenuate high level shock pulses while maintaining system alignment in the pre and post shock environment.